

TEST REPORT

Report No.: T211203D01-E

Applicant: Vecow Co.,Ltd

Address: 3F., No.10, Jiankang Rd., Zhonghe Dist., New Taipei City 23686, Taiwan (R.O.C.)

Manufacturer: Vecow Co.,Ltd

Address: 3F., No.10, Jiankang Rd., Zhonghe Dist., New Taipei City 23686, Taiwan (R.O.C.)

Equipment Under Test (EUT):

Name: MicroATX Mother Board

Brand Name: VECOW

Model No.: UMBC-1100

Added Model(s): UMBC-1XXXXXXXXXX("X" can be 0-9, A-Z or blank for marketing purpose)

Standards:

EN 55032: 2015 / A11: 2020 CISPR 32: 2015 (Ed 2.0) / C1: 2016 AS/NZS CISPR 32: 2015	
EN IEC 61000-3-2: 2019 EN 55035: 2017 / A11: 2020	EN 61000-3-3: 2013 / A1:2019
IEC 61000-4-2: 2008 / EN 61000-4-2: 2009	IEC 61000-4-6: 2013 + COR1: 2015 / EN 61000-4-6: 2014 + AC: 2015
IEC 61000-4-3: 2006 + A1: 2007 + A2: 2010 / EN 61000-4-3: 2006 + A1: 2008 + A2: 2010	IEC 61000-4-8: 2009 / EN 61000-4-8: 2010
IEC 61000-4-4: 2012 / EN 61000-4-4: 2012	IEC 61000-4-11: 2004 + A1: 2017 / EN 61000-4-11: 2004 + A1: 2017
IEC 61000-4-5: 2014 + A1: 2017 / EN 61000-4-5: 2014 + A1: 2017	

Date of Sample Receipt : December 3, 2021

Date of Test : December 20, 2021

Date of Issue : January 3, 2022

Remarks:

This test report can be used for CE and UKCA marking application which is based on equivalent requirements between UK and EU. It is appropriate using designated standards to provide presumption of conformity with GB law.

This report shall not be reproduced except in full, without approval of the Compliance Certification Services Inc. in writing. This document may be altered or revised by Compliance Certification Services Inc. personnel only. The applicant should not use it to claim product endorsement by TAF or any other Government agencies.

Disclaimer

Variants information between/among model numbers / trademarks is provided by the applicant, test results of this test report are applicable to the sample EUT received of main test model name

Approved By

Jason Lee (Section Manager)

Date

January 3, 2022



Unless otherwise stated the results shown in this test report refer only to the sample(s) tested and such sample(s) are retained for 90 days only.

除非另有說明，此報告結果僅對測試之樣品負責，同時此樣品僅保留 90 天。本報告未經本公司書面許可，不可部份複製。

This document is issued by the Company subject to its General Conditions of Service printed overleaf, available on request or accessible at <http://www.sgs.com.tw/Terms-and-Conditions> and, for electronic format documents, subject to Terms and Conditions for Electronic Documents at <http://www.sgs.com.tw/Terms-and-Conditions>. Attention is drawn to the limitation of liability, indemnification and jurisdiction issues defined therein. Any holder of this document is advised that information contained hereon reflects the Company's findings at the time of its intervention only and within the limits of client's instruction, if any. The Company's sole responsibility is to its Client and this document does not exonerate parties to a transaction from exercising all their rights and obligations under the transaction documents. This document cannot be reproduced, except in full, without prior written approval of the Company. Any unauthorized alteration, forgery or falsification of the content or appearance of this document is unlawful and offenders may be prosecuted to the fullest extent of the law.

Revision History

Revision	Report Number	Description	Issue Date
00	T211203D01-E	Original.	January 3, 2022

Note:

Contents

1. GENERAL DESCRIPTION	4
1.1 GENERAL DESCRIPTION OF EUT	4
1.2 DETAILS OF EUT	4
1.3 DESCRIPTION OF SUPPORT UNITS	4
1.4 I/O PORT DESCRIPTION.....	5
1.5 DECISION OF TEST MODE.....	6
1.6 THE FINAL TEST MODE OF THE EUT	6
1.7 CONFIGURATION OF TESTED SYSTEM	7
1.8 OPERATION PROCEDURE	7
1.9 SUMMARY OF RESULTS	8
1.10 REPORTING STATEMENTS OF CONFORMITY	8
1.11 DEVIATION	8
2. EMISSION.....	9
2.1 LIMIT	9
2.2 CONDUCTED EMISSION	11
2.3 RADIATED EMISSION	15
3. HARMONICS	19
3.1 TEST INSTRUMENTS	19
3.2 MEASUREMENT DATA.....	19
4. FLICKER.....	20
4.1 TEST INSTRUMENTS	20
4.2 MEASUREMENT DATA.....	21
5. IMMUNITY	22
5.1 STANDARD PERFORMANCE CRITERIA DESCRIPTION	22
5.2 SPECIAL PERFORMANCE CRITERIA DESCRIPTION	23
5.3 TEST OF IEC/EN 61000-4-2	29
5.4 TEST OF IEC/EN 61000-4-3	31
5.5 TEST OF IEC/EN 61000-4-4	34
5.6 TEST OF IEC/EN 61000-4-5	35
5.7 TEST OF IEC/EN 61000-4-6	36
5.8 TEST OF IEC/EN 61000-4-8	38
5.9 TEST OF IEC/EN 61000-4-11	39
APPENDIX.....	40
PHOTOGRAPH OF TESTING GENERAL SET-UP	40
PHOTOGRAPHS OF EUT UNIT	51

1. General Description

1.1 General Description of EUT

Name of EUT	MicroATX Mother Board
Brand Name	VECOW
Model No.(s)	UMBC-1100
Added Model(s)	UMBC-1XXXXXXXXXX("X" can be 0-9, A-Z or blank for marketing purpose)

Variant Description

Model Name	Difference	Tested (Checked)
UMBC-1100	Original	<input checked="" type="checkbox"/>
UMBC-1XXXXXXXXXX	1. "X" can be 0-9, A-Z or blank. 2. For marketing purpose only.	<input type="checkbox"/>

1.2 Details of EUT

EUT Power Rating	3.3VDC, 7.25A / \pm 5VDC, 0.58A / \pm 12VDC, 7.25A / 5VSB, 0.07A from Host PC Power Supply
Highest internal frequency	2100MHz

Accessories Cable List

Cable Type	Core	Length	Category	Shielding/Non-shielding

1.3 Description of Support Units

Host PC Devices:

No.	Equipment	Model No.	Brand Name
1	CPU (2.1GHz)	i5-8500T	Intel
2	Memory (4GB, DDR4-2400)	N/A	kingston
3	Storage(1TB)	SSD 3TG6-P	innodisk
4	Power Supply	EMG600AWT	EnerMax

Peripherals Devices:

No.	PRODUCT	MANUFACTURER	MODEL NO.	SERIAL NO.
1	Earphone & Microphone	HAWK	X710	N/A
2-5	USB HDD	Transcend	TS1TSJ25MC	N/A
6	USB Mouse	Logitech	M-U0026	N/A
7	USB Keyboard	Logitech	Y-U0011	N/A
8	Monitor	DELL	U2718Qb	CN-0M5R5F-QDC00-9CL-0CVL-A10
9	Monitor	ASUS	PA248Q	G5LMQS071170
10	Monitor	ViewSonic	VP2780-4K	N/A
11	Hub	ZYXEL	GS-108B v3	S184305016657
12	Server PC	DELL	T3610	57TT032

Support Equipment Used in Tested Cable

No.	Cable Type	Core	Length	Shielding/Non-shielding
1	Earphone & Microphone	N/A	1.8m	Non-shielding
2-5	USB	N/A	1.4m	Shielding
6	USB	N/A	1.5m	Shielding
7	USB	N/A	1.5m	Shielding
8	HDMI	N/A	2.0m	Shielding
9	VGA	2 cores	1.5m	Shielding
10	Display	N/A	2.0m	Shielding
11	RJ45	N/A	2m*4	Non-shielding
12	RJ45	N/A	20m	Non-shielding

1.4 I/O Port Description

I/O Port Types	Q'TY
1. VGA Port	1
2. HDMI Port	1
3. Display Port	1
4. Microphone Port	1
5. Earphone Port	1
6. USB Port	6
7. LAN Port	4

1.5 Decision of Test Mode

The test configuration modes are as the following:

Conduction Modes (Power port):

1	DP Mode 4096*2160, 60Hz; HDMI Mode 3840*2160, 24Hz;	100VAC, 50Hz
2	VGA Mode 1920*1200, 60Hz	230VAC, 50Hz

Conduction Modes (Wired network ports):

1		10Mbps
2	LAN 1	100Mbps
3		1Gbps
4	LAN 2	1Gbps
5		10Mbps
6	LAN 4	100Mbps
7		1Gbps

Radiation Modes:

1	DP Mode 4096*2160, 60Hz; HDMI Mode 3840*2160, 24Hz; VGA Mode 1920*1200, 60Hz	100VAC, 50Hz
2	DP Mode 4096*2160, 60Hz; HDMI Mode 3840*2160, 24Hz; VGA Mode 1920*1200, 60Hz / 1-6GHz	230VAC, 50Hz

1.6 The Final Test Mode of the EUT

After the preliminary scan, the following test mode was found to produce the highest emission level.

Final Test Mode	
Conducted Emission	Mode 2
ISN	Mode 5
Radiated Emission Below 1GHz	Mode 2
Radiated Emission Above 1GHz	Mode 2
Harmonics & Flicker	Mode 2
Immunity	Mode 2

Then, the above highest emission mode of the configuration of the EUT and cable was chosen for all final test items.

1.7 Configuration of Tested System

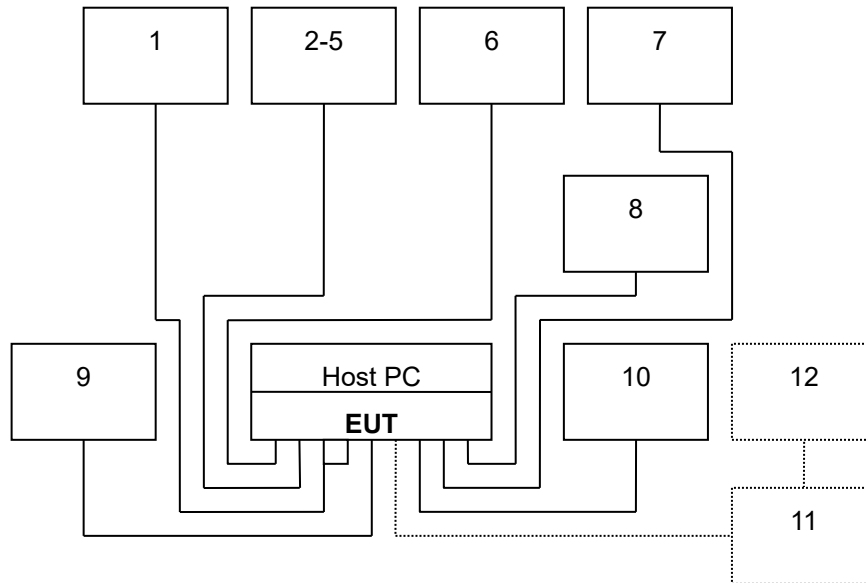

1.8 Operation Procedure

1. Windows Server 10 boots system.
2. Run colorbarmove.mp4 to activate all peripherals for test EUT.
3. Run Burnintest.exe to activate all peripherals for test EUT.
4. Run Lantest20.exe to ping 192.168.1.10 -t (EUT), ping 192.168.1.20 -t (EUT), ping 192.168.1.30 -t (EUT), ping 192.168.1.40 -t (EUT), ping 192.168.1.22 -t (Server Notebook).

1.9 Summary of Results

Emission		
Standard	Test Type	Result
EN 55032: 2015 / A11: 2020	Conducted Emission	PASS
CISPR 32: 2015 (Ed 2.0) / C1: 2016	ISN	PASS
AS/NZS CISPR 32: 2015	Radiated Emission	PASS
EN IEC 61000-3-2: 2019	Harmonic current emissions	PASS
EN 61000-3-3: 2013 / A1:2019	Voltage changes, voltage fluctuations & flicker	PASS

Immunity			
Standard	Test Type	Result	Performance Criteria
IEC 61000-4-2: 2008 / EN 61000-4-2: 2009	ESD	PASS	B
IEC 61000-4-3: 2006 + A1: 2007 + A2: 2010 / EN 61000-4-3: 2006 + A1: 2008 + A2: 2010	RS	PASS	A
IEC 61000-4-4: 2012 / EN 61000-4-4: 2012	EFT	PASS	B
IEC 61000-4-5: 2014 + A1: 2017 / EN 61000-4-5: 2014 + A1: 2017	Surge	PASS	B
IEC 61000-4-6: 2013 + COR1: 2015 / EN 61000-4-6: 2014 + AC: 2015	CS	PASS	A
IEC 61000-4-8: 2009 / EN 61000-4-8: 2010	PFMF	N/A	A
IEC 61000-4-11: 2004 + A1: 2017 / EN 61000-4-11: 2004 + A1: 2017	DIP	PASS	C/C/B

1.10 Reporting Statements of Conformity

The conformity statement in this report is based solely on the test results, measurement uncertainty is excluded.

1.11 Deviation

No deviation from the mentioned test methods and applicable standards.

2.EMISSION

2.1 Limit

Maximum permissible level of Line Conducted Emission

FREQUENCY (MHz)	Class A(dBuV)		Class B(dBuV)	
	Quasi-peak	Average	Quasi-peak	Average
0.15 - 0.5	79	66	66 - 56	56 - 46
0.50 - 5.0	73	60	56	46
5.0 - 30.0	73	60	60	50

Note: The lower limit shall apply at the transition frequency.

Maximum permissible level of Common Mode Conducted Emission (Asymmetric Mode)

Class A

FREQUENCY (MHz)	Voltage Limit(dBuV)		Current Limit(dBuA)	
	Quasi-peak	Average	Quasi-peak	Average
0.15 - 0.5	97 - 87	84 - 74	53 - 43	40 - 30
0.5 - 30.0	87	74	43	30

Class B

FREQUENCY (MHz)	Voltage Limit(dBuV)		Current Limit(dBuA)	
	Quasi-peak	Average	Quasi-peak	Average
0.15 - 0.5	84 - 74	74 - 64	40 - 30	30 - 20
0.5 - 30.0	74	64	30	20

Note: The lower limit shall apply at the transition frequency.

Maximum permissible level of Radiated Emission measured at 10 meter

FREQUENCY (MHz)	Class A(dBuV/m)	Class B(dBuV/m)
	Quasi - peak	Quasi - peak
30 - 230	40	30
230 - 1000	47	37

Note: The lower limit shall apply at the transition frequency.

Maximum permissible level of Radiated Emission measured at 3 meter

Frequency range (MHz)	Class A(dBuV/m)	Class B(dBuV/m)
	Quasi - peak	Quasi - peak
30 - 230	50	40
230 - 1000	57	47

Note: The lower limit shall apply at the transition frequency.

Limits above 1 GHz

Limits for radiated disturbance of Class A ITE at a measurement distance of 3m

Frequency range (GHz)	Average Limit dB(μ V/m)	Peak Limit dB(μ V/m)
1 - 3	56	76
3 - 6	60	80

Note: The lower limit applies at the transition frequency.

Limits for radiated disturbance of Class B ITE at a measurement distance of 3m

Frequency range (GHz)	Average Limit dB(μ V/m)	Peak Limit dB(μ V/m)
1 - 3	50	70
3 - 6	54	74

Note: The lower limit applies at the transition frequency.

Requirements for radiated emissions from FM receivers

Frequency range (MHz)	Measurement				Class B Limit dB(μ V/m)
	Facility	Distance (m)	Detector type / Bandwidth	Fundamental	Harmonics
30 - 230	OATS/SAC	10	Quasi Peak / 120 kHz	50	42
230 - 300					42
300 - 1000					46
30 - 230	OATS/SAC	3	Quasi Peak / 120 kHz	60	52
230 - 300					52
300 - 1000					56

These relaxed limits apply only to emissions at the fundamental and harmonic frequencies of the LO. Signals at all other frequencies shall be compliant with the limits

Note: SAC: Semi Anechoic Chamber

OATS: Open Area Test Site

2.2 Conducted Emission

2.2.1 Test Instruments

Conducted Emission Room # A					
EQUIPMENT TYPE	Manufacturer	Model Number	Serial Number	Calibration Date	Calibration Due
Pulse Limiter	Schwarzbeck	VTSD 9561-F	BNC#211	03/24/2021	03/23/2022
BNC CABLE	EMEC	EMG178	BNC#A9	03/24/2021	03/23/2022
EMI Test Receiver	R&S	ESCI	100234	05/04/2021	05/03/2022
ISN	Teseq	ISN T800	29449	07/22/2021	07/21/2022
LISN	Schwarzbeck	NNLK 8129	8129-286	07/21/2021	07/20/2022
LISN(EUT)	Schwarzbeck	NSLK 8127	8127527	07/21/2021	07/20/2022
Thermo-Hygro Meter	Wisewind	201A	SD-C017	04/13/2021	04/12/2022
Test S/W	EZ-EMC				
Testing Site : No.163-1, Jhongsheng Rd., Xindian Dist., New Taipei City, Taiwan					
Measurement Uncertainty of Conducted Emission					
Expanded uncertainty Ulab (k=2) of Conducted Emission is 2.8 dB.					
Expanded uncertainty Ulab (k=2) of ISN Conducted Emission is 3.2 dB					
Expanded uncertainty CISPR 16-4-2:2011+A1:2014+A2:2018 (k=2) of Conducted Emission measurement is 3.8 dB.					
Expanded uncertainty CISPR 16-4-2:2011+A1:2014+A2:2018 (k=2) of ISN Conducted Emission measurement is 5.0 dB.					

2.2.2 Measurement Level Calculation

Factor = LISN insertion loss + Cable loss + Pulse Limiter insertion loss

Measurement Level = Reading Level + Factor

Over (Margin) = Measurement Level – Limit

2.2.3 Measurement Data (CE)

Model No.	UMBC-1100	6dB Bandwidth	9 kHz
Environmental Conditions	23.8°C, 58% RH	Test Mode	Mode 2
Tested by	Jim Lian	Phase	L1
Standard	EN 55032 CLASS A		

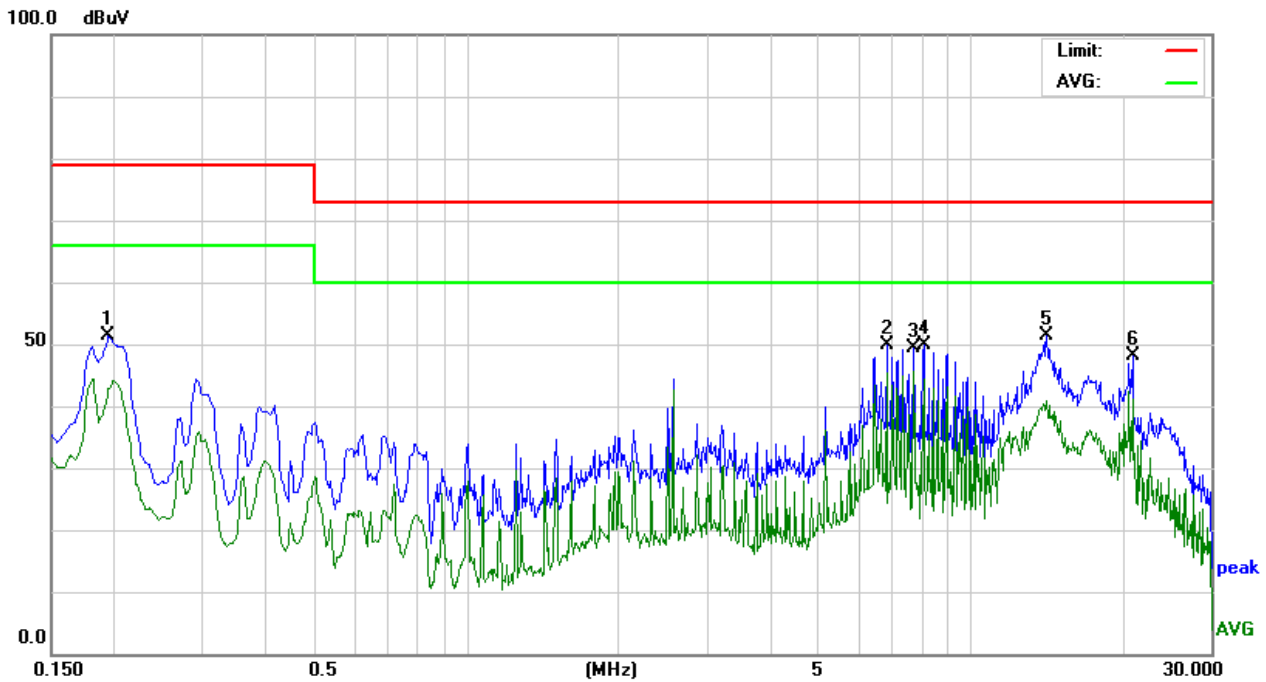

Conducted Emission Readings							
Frequency Range Investigated				150 kHz to 30 MHz			
Freq. (MHz)	Reading (dBuV)	Factor (dB)	Result (dBuV)	Limit (dBuV)	Margin (dB)	Detector (P/Q/A)	Line (L1/L2)
0.1949	41.64	9.72	51.36	79.00	-27.64	P	L1
6.8145	39.68	10.16	49.84	73.00	-23.16	P	L1
7.7145	39.25	10.20	49.45	73.00	-23.55	P	L1
8.0700	39.58	10.21	49.79	73.00	-23.21	P	L1
14.1585	40.93	10.43	51.36	73.00	-21.64	P	L1
20.9310	37.54	10.60	48.14	73.00	-24.86	P	L1

Note: 1. L1 = Line One (Live Line) / L2 = Line Two (Neutral Line).

Model No.	UMBC-1100	6dB Bandwidth	9 kHz
Environmental Conditions	23.8°C, 58% RH	Test Mode	Mode 2
Tested by	Jim Lian	Phase	L2
Standard	EN 55032 CLASS A		

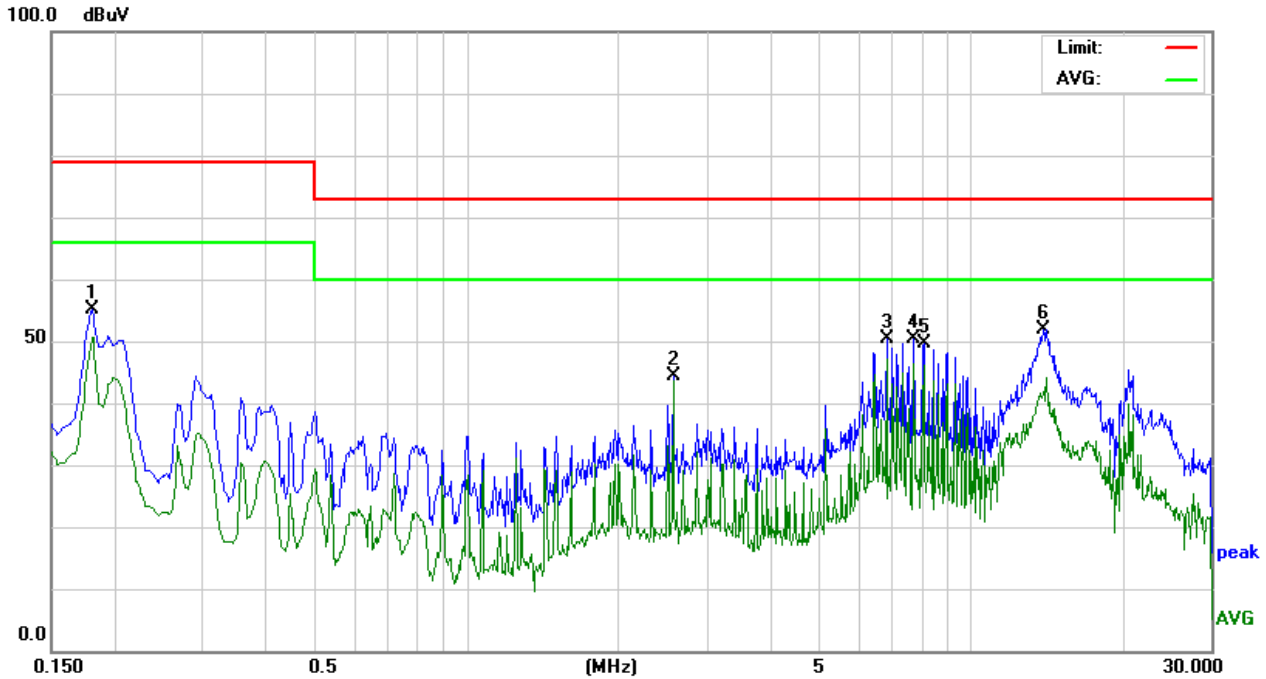

Conducted Emission Readings							
Frequency Range Investigated				150 kHz to 30 MHz			
Freq. (MHz)	Reading (dBuV)	Factor (dB)	Result (dBuV)	Limit (dBuV)	Margin (dB)	Detector (P/Q/A)	Line (L1/L2)
0.1815	45.54	9.70	55.24	79.00	-23.76	P	L2
2.5755	34.58	9.90	44.48	73.00	-28.52	P	L2
6.8145	40.31	10.06	50.37	73.00	-22.63	P	L2
7.7100	40.33	10.09	50.42	73.00	-22.58	P	L2
8.0700	39.62	10.10	49.72	73.00	-23.28	P	L2
13.9785	41.65	10.31	51.96	73.00	-21.04	P	L2

Note: 1. L1 = Line One (Live Line) / L2 = Line Two (Neutral Line).

2.2.4 Measurement Data (ISN)

Model No.	UMBC-1100	6dB Bandwidth	9 kHz
Environmental Conditions	23.8°C, 58% RH	Test Mode	Mode 5
Tested by	Jim Lian	Standard	EN 55032 CLASS A

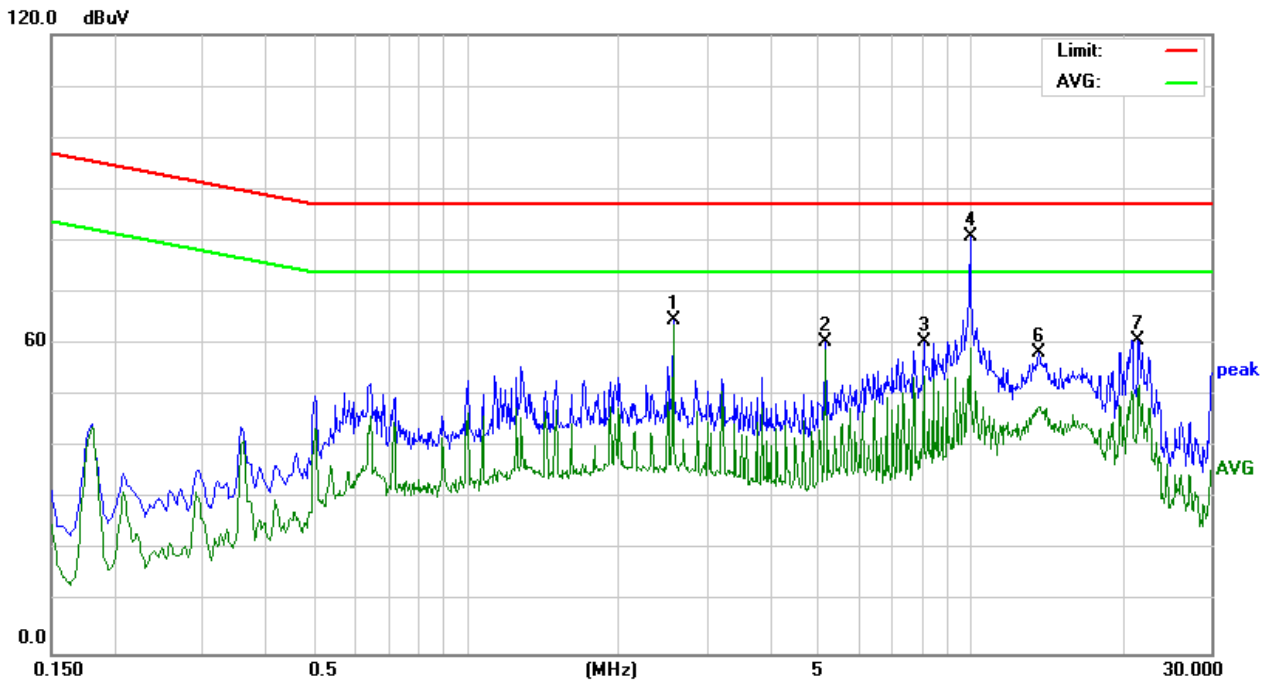

Conducted Emission Readings						
Frequency Range Investigated				150 kHz to 30 MHz		
Freq. (MHz)	Reading (dBuA)	Factor (dB)	Result (dBuA)	Limit (dBuA)	Margin (dB)	Detector (P/Q/A)
2.5755	45.20	19.34	64.54	87.00	-22.46	P
5.1495	41.14	19.37	60.51	87.00	-26.49	P
8.0834	41.01	19.38	60.39	87.00	-26.61	P
9.9960	61.49	19.39	80.88	87.00	-6.12	P
9.9960	39.95	19.39	59.34	74.00	-14.66	A
13.6500	38.78	19.51	58.29	87.00	-28.71	P
21.5475	41.21	19.68	60.89	87.00	-26.11	P

2.3 Radiated Emission

2.3.1 Test Instruments

Below 1GHz

Open Area Test Site # H					
EQUIPMENT TYPE	Manufacturer	Model Number	Serial Number	Calibration Date	Calibration Due
Bilog Antenna	Teseq	CBL 6112D	40529	09/23/2021	09/22/2022
Cable	EMEC	CFD400E-LW	SD-R074	08/12/2021	08/11/2022
EMI Test Receiver	R&S	ESCI	101340	02/26/2021	02/25/2022
Pre-Amplifier	HP	8447D	1937A01554	09/24/2021	09/23/2022
Thermo-Hygro Meter	Wisewind	201A	No. 03	05/20/2021	05/19/2022
Test S/W	EZ-EMC				
Testing Site : No.163-1, Jhongsheng Rd., Xindian Dist., New Taipei City, Taiwan					
Measurement Uncertainty of Radiated Emission					
Expanded uncertainty U _{lab} (k=2) of Radiated Emission is 5.2 dB.(30MHz-1000MHz)					
Expanded uncertainty CISPR 16-4-2:2011+A1:2014+A2:2018 (k=2) of Radiated Emission measurement is 5.2 dB.(30MHz-1000MHz)					

Above 1GHz

Chamber # E					
EQUIPMENT TYPE	Manufacturer	Model Number	Serial Number	Calibration Date	Calibration Due
Horn Antenna	ETS	3117	00139062	07/14/2021	07/13/2022
Microflex Cable x 7m	EMCI	EMC107-NM-NM-7000	SD-R072	07/28/2021	07/27/2022
K-Type Cable x 1m	EMCI	EMC101G-KM-KM-1000	200702	07/05/2021	07/04/2022
Pre-Amplifier	Com-Power	PAM-118A	551041	07/07/2021	07/06/2022
Signal Analyzer	R&S	FSV40	101269	07/06/2021	07/05/2022
Thermo-Hygro Meter	Wisewind	201A	SD-R046	08/10/2021	08/09/2022
Test S/W	EZ-EMC				
Testing Site : No.163-1, Jhongsheng Rd., Xindian Dist., New Taipei City, Taiwan					
Measurement Uncertainty of Radiated Emission					
Expanded uncertainty (k=2) of Radiated Emission measurement is 4.6 dB.(1-6GHz)					
Expanded uncertainty CISPR 16-4-2:2011+A1:2014+A2:2018 (k=2) of Radiated Emission measurement is 5.5 dB.(1-6GHz)					

2.3.2 Measurement Level Calculation

Correction Factor = Antenna Factor + Cable loss- Amplifier Gain
 Measurement Level = Reading Level + Correction Factor
 Over (Margin) = Measurement Level – Limit

2.3.3 Measurement Data

Below 1GHz

Model No.	UMBC-1100	Test Mode	Mode 2
Environmental Conditions	23.3°C, 64% RH	6dB Bandwidth	120 kHz
Antenna Pole	Vertical	Antenna Distance	10m
Detector Function	Quasi-peak.	Tested by	Jim Lian
Standard	EN 55032 CLASS A		

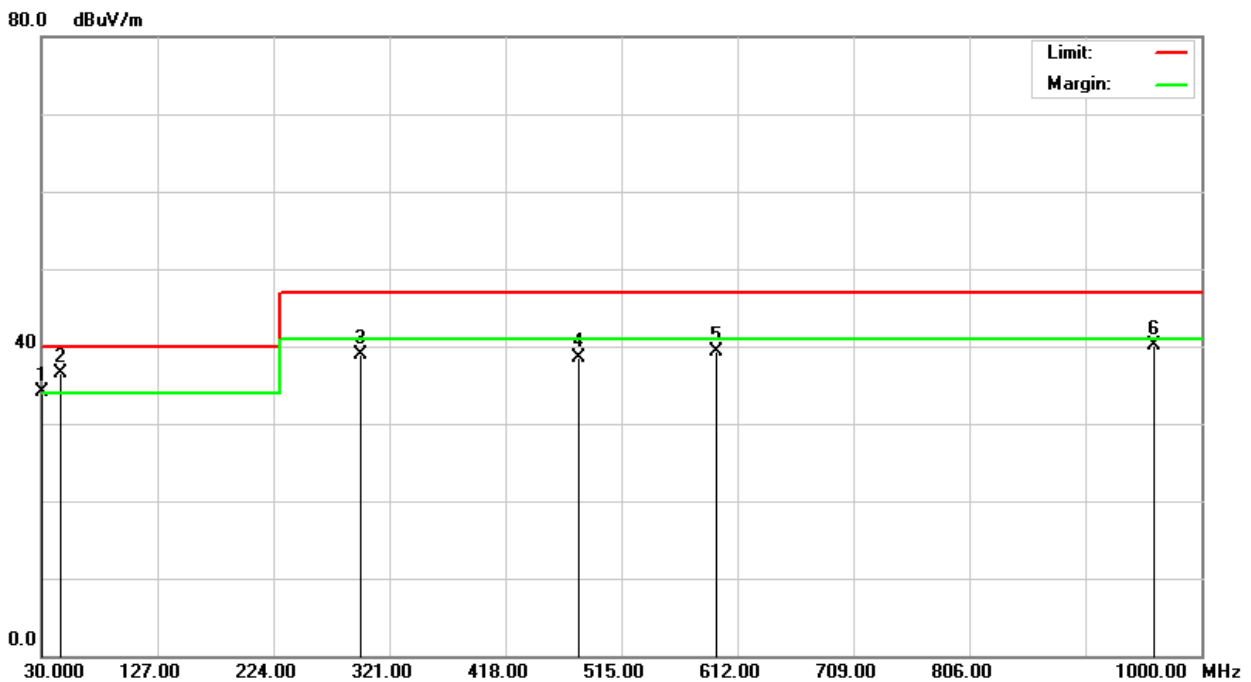

Radiated Emission Readings									
Frequency Range Investigated				30 MHz to 1000 MHz at 10m					
Freq. (MHz)	Reading (dBuV)	Factor (dB/m)	Result (dBuV/m)	Limit (dBuV/m)	Margin (dB)	Height (cm)	Degree (°)	Detector (P/Q)	Pol. (H/V)
30.3600	36.50	-2.47	34.03	40.00	-5.97	100	158	Q	V
46.2400	47.60	-11.15	36.45	40.00	-3.55	100	246	Q	V
296.7140	44.90	-6.09	38.81	47.00	-8.19	100	199	Q	V
480.0120	39.80	-1.21	38.59	47.00	-8.41	400	302	Q	V
593.9600	38.70	0.53	39.23	47.00	-7.77	400	82	Q	V
960.0100	35.40	4.67	40.07	47.00	-6.93	400	75	Q	V

Note: 1. P= Peak Reading; Q= Quasi-peak Reading.

Model No.	UMBC-1100	Test Mode	Mode 2
Environmental Conditions	23.3°C, 64% RH	6dB Bandwidth	120 kHz
Antenna Pole	Horizontal	Antenna Distance	10m
Detector Function	Quasi-peak.	Tested by	Jim Lian
Standard	EN 55032 CLASS A		

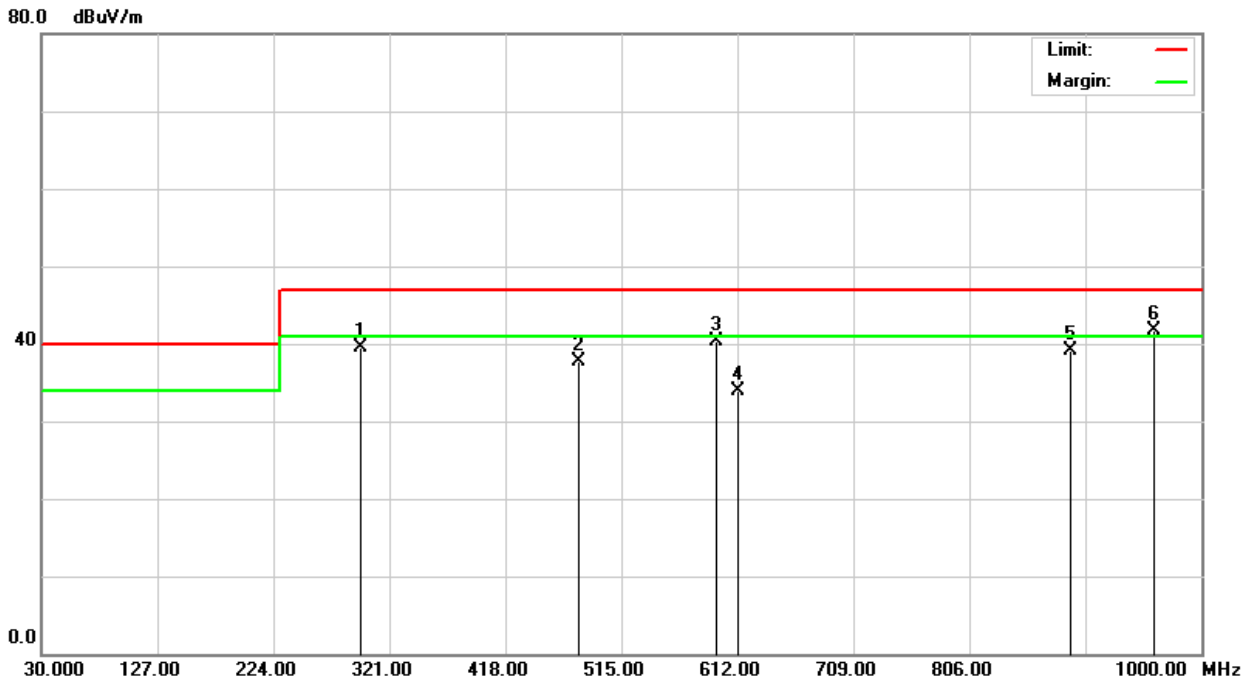

Radiated Emission Readings									
Frequency Range Investigated				30 MHz to 1000 MHz at 10m					
Freq. (MHz)	Reading (dBuV)	Factor (dB/m)	Result (dBuV/m)	Limit (dBuV/m)	Margin (dB)	Height (cm)	Degree (°)	Detector (P/Q)	Pol. (H/V)
297.7100	45.60	-6.08	39.52	47.00	-7.48	400	101	Q	H
480.0100	39.00	-1.21	37.79	47.00	-9.21	100	281	Q	H
593.9800	39.70	0.53	40.23	47.00	-6.77	100	64	Q	H
613.2000	33.00	0.87	33.87	47.00	-13.13	100	339	Q	H
890.1300	35.10	3.95	39.05	47.00	-7.95	100	97	Q	H
960.1000	37.10	4.67	41.77	47.00	-5.23	100	175	Q	H

Note: 1. P= Peak Reading; Q= Quasi-peak Reading.

Above 1GHz

Model No.	UMBC-1100	Test Mode	Mode 2
Environmental Conditions	25.3°C, 65% RH	6dB Bandwidth	1 MHz
Antenna Pole	Vertical / Horizontal	Antenna Distance	3m
Highest frequency generated or used	2100MHz	Upper frequency	6000MHz
Detector Function	Peak and average.	Tested by	Lion Lee
Standard	EN 55032 CLASS A		

Radiated Emission Readings							
Frequency Range Investigated				Above 1GHz at 3m			
Freq. (MHz)	Reading (dBuV)	Factor (dB/m)	Result (dBuV/m)	Limit (dBuV/m)	Margin (dB)	Detector (P/A)	Pol. (H/V)
1000.000	58.28	-8.66	49.62	76.00	-26.38	P	V
1185.000	62.17	-8.58	53.59	76.00	-22.41	P	V
1240.000	63.06	-8.66	54.40	76.00	-21.60	P	V
2490.000	54.23	-4.93	49.30	76.00	-26.70	P	V
2735.000	57.15	-4.83	52.32	76.00	-23.68	P	V
4750.000	58.05	-2.14	55.91	80.00	-24.09	P	V

Radiated Emission Readings							
Frequency Range Investigated				Above 1GHz at 3m			
Freq. (MHz)	Reading (dBuV)	Factor (dB/m)	Result (dBuV/m)	Limit (dBuV/m)	Margin (dB)	Detector (P/A)	Pol. (H/V)
1000.000	61.19	-8.66	52.53	76.00	-23.47	P	H
1185.000	60.52	-8.58	51.94	76.00	-24.06	P	H
1780.000	60.15	-6.82	53.33	76.00	-22.67	P	H
2735.000	57.50	-4.83	52.67	76.00	-23.33	P	H
3600.000	56.32	-4.29	52.03	80.00	-27.97	P	H
4750.000	58.93	-2.14	56.79	80.00	-23.21	P	H

Note: 1. P= Peak Reading; A= Average Reading.

3. Harmonics

3.1 Test Instruments

Immunity A					
EQUIPMENT TYPE	Manufacturer	Model Number	Serial Number	Calibration Date	Calibration Due
5kVA Power Source	Teseq	NSG 1007-5	1537A01296	03/10/2021	03/09/2022
Signal Conditioning Unit	Teseq	NSG 1000-1	1846A01831	03/10/2021	03/09/2022
Test Software	WIN2100V4 Ver. 4.22				
Testing Site : No.163-1, Jhongsheng Rd., Xindian Dist., New Taipei City, Taiwan					

3.2 Measurement Data

Test Result: N/L Source qualification: Normal
 THC(A): 0.085 I-THD(%): 32.1 POHC(A): 0.010 POHC Limit(A): 0.017

Highest parameter values during test:

V_RMS (Volts): 229.80	Frequency(Hz): 50.00
I_Peak (Amps): 1.365	I_RMS (Amps): 0.409
I_Fund (Amps): 0.265	Crest Factor: 3.527
Power (Watts): 39.1	Power Factor: 0.464

Note: According to clause 7 of EN 61000-3-2, equipment with a rated power of 75W or less, no limits apply. The test result is only for reference.

4. Flicker

4.1 Test Instruments

Immunity A					
EQUIPMENT TYPE	Manufacturer	Model Number	Serial Number	Calibration Date	Calibration Due
5kVA Power Source	Teseq	NSG 1007-5	1537A01296	03/10/2021	03/09/2022
Signal Conditioning Unit	Teseq	NSG 1000-1	1846A01831	03/10/2021	03/09/2022
Test Software	WIN2100V4 Ver. 4.22				
Testing Site : No.163-1, Jhongsheng Rd., Xindian Dist., New Taipei City, Taiwan					

4.2 Measurement Data

Test Result: Pass

Status: Test Completed

Pst_i and limit line

European Limits

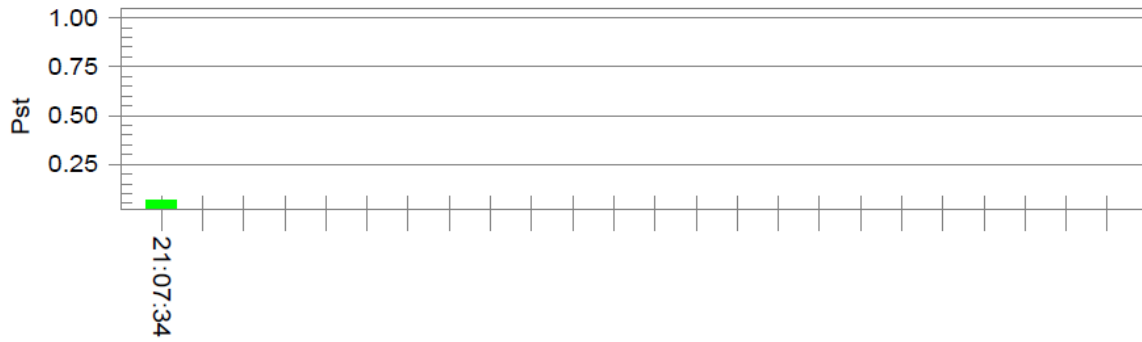

Plt and limit line

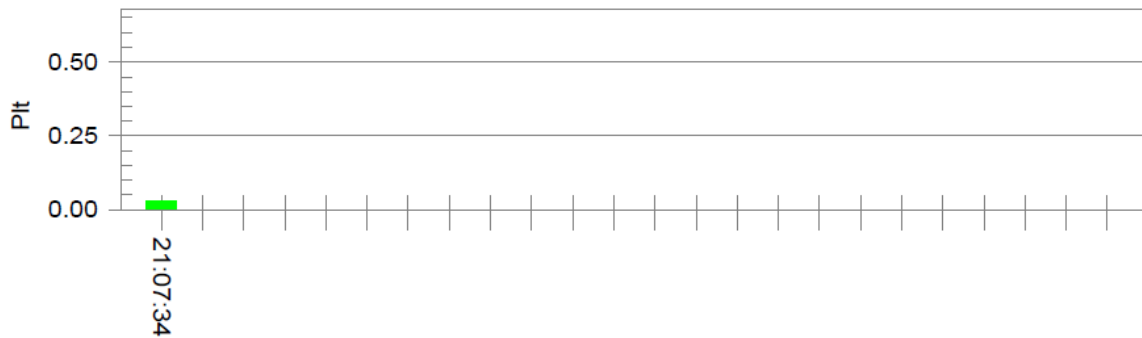

Parameter values recorded during the test:

Vrms at the end of test (Volt):	229.72		
Highest dt (%):		Test limit (%):	
T-max (mS):	0	Test limit (mS):	500.0 Pass
Highest dc (%):	0.00	Test limit (%):	3.30 Pass
Highest dmax (%):	0.00	Test limit (%):	4.00 Pass
Highest Pst (10 min. period):	0.064	Test limit:	1.000 Pass
Highest Plt (2 hr. period):	0.028	Test limit:	0.650 Pass

5. IMMUNITY

5.1 STANDARD PERFORMANCE CRITERIA DESCRIPTION

- Criterion A - The apparatus shall continue to operate as intended. No degradation of performance or loss of function is allowed below a performance level specified by the manufacturer, when the apparatus is used as intended.
- Criterion B - The apparatus shall continue to operate as intended after the test. No degradation of performance or loss of function is allowed below a performance level specified by the manufacturer, when the apparatus is used as intended.
- Criterion C - Temporary loss of function is allowed, provided the function is self recoverable or can be restored by the operation of the controls.

5.2 SPECIAL PERFORMANCE CRITERIA DESCRIPTION

5.2.1 Performance Criteria Description for Print function

Criterion A - Apply criterion A as defined in 8.2. Additionally, the following shall not occur as a consequence of the application of the disturbance:

- change of operating state;
- unintended pausing of the print operation;
- a change of print quality or legibility, as appropriate to the test pattern;
- change of character font;
- unintended line feed;
- unintended page feed;
- paper feed failure.

Criterion B - Apply criterion B as defined in 8.3 with the following specifics and additional limitations. Paper feed failures are allowed only if, after removal of the jammed sheets, the job is automatically recovered and there is no loss of printed information. Any low-quality print output caused by the application of the disturbance shall not continue beyond the sheet of media being printed, or beyond the typical length of a finished page or sheet printed from continuous roll media. False indicators are permitted during the test provided that a normal operator response to that false indicator is simple (such as pressing a button). False indicators are not acceptable if they would cause the user to discard printing supplies such as ink, toner or paper, when those supplies are actually not empty or faulty. Any false indicator shall either clear automatically or after the operator's response. After the disturbance, the print function may print the remainder of the print job at a quality level within the manufacturer's specifications. Alternately, the print function may halt processing of a print job as a result of the disturbance, but only if the operator is capable of reprinting the job (for example, a fax printing job where the image to be printed still resides in local memory). Automatically restarting the print job from the beginning is also acceptable. In any scenario, the pairing of front and back images during double-sided printing shall be correct.

Criterion C - Temporary loss of function is allowed, provided the function is self recoverable or can be restored by the operation of the controls.

5.2.2 Performance Criteria Description for Scan function

- Criterion A - Apply criterion A as defined in 8.2. Additionally, the following shall not occur as a consequence of the application of the test:
- change of settings, such as which side(s) of the page to be scanned, colour or monochrome, and resolution;
 - corruption of the image, for example stretching, compressing or change in colour;
 - paper feed failures;
 - errors in the reading of bar codes.
- Criterion B - Apply criterion B as defined in 8.3 with the following specifics and additional limitations.
- Document feed failures are allowed only if the original documents are undamaged and, after removal of the jammed sheets, the job is automatically recovered and there is no loss of scanned information.
 - During the test, the representation of the image shall not be degraded such that reading mistakes occur.
- Criterion C - Temporary loss of function is allowed, provided the function is self recoverable or can be restored by the operation of the controls.

5.2.3 Performance Criteria Description for Display and display output function

- Criterion A - Apply criterion A as defined in 8.2. Additionally, an increase in any degradation greater than just perceptible by observation of the image shall not occur as a consequence of the application of the test. Examples of such degradations are:
- superimposed patterning;
 - positional disturbances due to synchronisation errors;
 - geometric distortion;
 - change of contrast or brightness;
 - picture artefacts;
 - freezing or disturbance of motion;
 - image loss;
 - video data or decoding errors.
- Criterion B - The apparatus shall continue to operate as intended after the test. No degradation of performance or loss of function is allowed below a performance level specified by the manufacturer, when the apparatus is used as intended.
- Criterion C - Temporary loss of function is allowed, provided the function is self recoverable or can be restored by the operation of the controls.

5.2.4 Performance Criteria Description for Musical tone generating function

- Criterion A - Performance criterion A is subdivided according to the type of equipment and its use. Three subgroups corresponding to different equipment types are defined in Table E.1 and have corresponding performance criteria A1, A2 and A3. The relevant subgroup shall be selected by the manufacturer in accordance with the product specification. The description of criteria A1, A2 and A3 are presented in Table E.2.
- Criterion B - During the test, degradation of performance beyond that defined in criterion A1 of Table E.2 is allowed. However, sudden amplification of tone to a level that exceeds the expected level by more than 6 dB is not allowed. After the test, normal operation of the EUT shall be self-recovered. In the case of unintended tone holding caused by a MIDI protocol communication error, the EUT can be re-initialised by the operation of the controls by the user controls in accordance with the manufacturer's instructions. Due to the nature of the MIDI protocol, it is necessary to modify the performance criterion B to allow user intervention when the unintended tone holding is caused by a missing MIDI communication error (for example missing a 'NOTE OFF' message).
- Criterion C - Degradation of the performance beyond that defined in criterion A1 of Table E.2 is permitted provided that the normal operation of the EUT can be restored after the test by operator intervention. However, sudden amplification of tone to a level that exceeds the expected level by more than 6 dB is not allowed.

5.2.5 Performance Criteria Description for Networking function

Criterion A - Where relevant, during the application of the test the network function shall, as a minimum, operate ensuring that:

- established connections shall be maintained throughout the application of the test;
- no change of operational state or corruption of stored data occurs;
- no increase in error rate above the figure defined by the manufacturer occurs. The manufacturer should select the most appropriate performance measurement criteria for the product or system, for example bit error rate, block error rate;
- no request for retry above the figure defined by the manufacturer;.
- the data transmission rate does not reduce below the figure defined by the manufacturer;
- no protocol failure occurs;
- the audio noise level at a two-wire analogue interface (supporting telephony) shall satisfy the requirements of Table G.3. The audio level measurements shall be performed at the demodulated frequency of the disturbance using a narrowband filter with a 3 dB bandwidth of 100 Hz using the method defined in table clause G.1.4. See G.6.1. As described in the example given in J.3.5 the networking function is monitored during testing using direct functions specified elsewhere in this document. If needed to verify the operation of the protocol, the following functions shall be verified as described in Table H.1 when performing the additional spot frequency tests contained in Clause 5:
 - ability to establish a connection,
 - ability to clear a connection.

Where an EUT has supervisory functions they shall not be affected. Elements that should be monitored include, but are not limited to:

- alarms,
- signalling lamps,
- printer output errors,
- network traffic rates,
- network monitor errors,
- measured network parameters.

Criterion B - Established connections shall be maintained throughout the test, or shall self-recover in a way and timescale that is imperceptible to the user.

The error rate, request for retry and data transmission rates may be degraded during the application of the test. Degradation of the performance as described in criterion A is permitted, provided that the normal operation of the EUT is self-recoverable to the condition established prior to the application of the test. Where required, as defined in Clause 5, the acceptable operation of the function shall be verified at the completion of the test as described in Table H.1, by confirming the following:

- the EUT's ability to establish a connection,
- the EUT's ability to clear a connection.

During surge testing disconnection is allowed on the analogue/digital data port being tested. If the EUT is a supervisory equipment, it shall not impact the normal operation of the network being monitored. In addition, any supervisory functions impacted during the period of the test shall return to the state prior to the test. Elements to consider include:

- alarms,
- signalling lamps,
- printer output,
- network traffic rates,
- network monitoring. is used as intended.

Criterion C - Degradation of performance as described in criteria A and B is permitted provided that the normal operation of the EUT is self-recoverable to the condition immediately before the application of the test, or can be restored after the test by the operator.

5.2.6 Performance Criteria Description for Audio output function

Criterion A - The interference ratio (electrical or acoustic) shall meet the limits in column 3; or,
the acoustic level of the demodulated audio shall be less than the limits in column 4; or,
the digitally coded level of demodulated audio shall be less than limits in column 5; or,
the analogue level of the demodulated audio shall be less than the limits in column 6.

Criterion B - The apparatus shall continue to operate as intended after the test. No degradation of performance or loss of function is allowed below a performance level specified by the manufacturer, when the apparatus is used as intended.

Criterion C - Temporary loss of function is allowed, provided the function is self recoverable or can be restored by the operation of the controls.

5.2.7 Performance Criteria Description for Telephony function

Function to be exercised	Performance criteria		
	A	B	C
Establish new communication	At the additional spot frequency tests a, c	Performed before and after the application of the test or disturbance	Performed before and after the application of the test or disturbance
Maintain established communication	Yes In addition, the requirements of Annex G for the audio output function shall be satisfied c	Yes b	No
Terminate established communication	At the additional spot frequency tests a, c	Performed before and after the application of the test or disturbance	Performed before and after the application of the test or disturbance

Communication refers to a telephone call or other form of voice connection.

a Applicable to TTE with a dial function that provides dedicated emergency service/safety of life call capability. Where the EUT does not provide this functionality, this limitation shall be stated in the equipment user manual.

b Communication shall be established prior to the application of the disturbance, the communication shall be maintained and the quality of that communication (for example, volume setting, the level of background noise) shall be maintained after completion of the test or disturbance.

c Where defined in Clause 5 (for the tests in Table 1 to Table 4), these functional tests shall be performed during the additional spot frequency tests.

5.3 Test of IEC/EN 61000-4-2

5.3.1 Test Instruments

Immunity Shielded Room					
EQUIPMENT TYPE	Manufacturer	Model Number	Serial Number	Calibration Date	Calibration Due
Aneroid Barometer	SATO	7610-20	89090	08/13/2021	08/12/2022
ESD Simulator	Teseq	NSG 437	1189	04/19/2021	04/18/2022
Thermo-Hygro Meter	Wisewind	201A	SD-S039	01/06/2021	01/05/2022
Testing Site : No.163-1, Jhongsheng Rd., Xindian Dist., New Taipei City, Taiwan					

5.3.2 EUT Operating Condition

Environment:

Temperature	Humidity	Air Pressure
23 °C	46 %RH	1001 hpa

5.4 Test of IEC/EN 61000-4-3

5.4.1 Test Instruments

844 RS Chamber					
EQUIPMENT TYPE	Manufacturer	Model Number	Serial Number	Calibration Date	Calibration Due
Electric Field Probe	AR	FL7006	0356656	10/16/2021	10/15/2022
Field of Calibration	CCS	Chamber#RS	80-1000MHz	02/26/2021	02/25/2022
RF Power Meter	Boonton	4242	17419	03/17/2021	03/16/2022
Power Sensor	Boonton	51011A-EMC	36833	03/17/2021	03/16/2022
Power Sensor	Boonton	51011A-EMC	36834	03/17/2021	03/16/2022
Signal Generator	Agilent	N5181A	MY47421336	09/14/2021	09/13/2022
Thermo-Hygro Meter	Wisewind	N/A	SD-S019	10/05/2021	10/04/2022
Broadband Antenna	Schwarzbeck	VUSLP 9111E	D-69250	N.C.R	N.C.R
Power Amplifier	Milmega	80RF1000-600	1079361	N.C.R	N.C.R
Field of Calibration	CCS	Chamber#RS	1000-6000M	02/25/2021	02/24/2022
Direction Coupler	AR	DC7144A	306217	N.C.R	N.C.R
Microwave Antenna	Schwarzbeck	STLP 9149	767	N.C.R	N.C.R
Power Amplifier	AR	60S1G3	302728	N.C.R	N.C.R
Power Amplifier	Milmega	AS1860-100	1075832	N.C.R	N.C.R
Power Amplifier	Teseq	CBA6G-100D	1087370	N.C.R	N.C.R
Test Software	EmcwareVer. 2.6.0.16				
Testing Site : No.163-1, Jhongsheng Rd., Xindian Dist., New Taipei City, Taiwan					

5.4.2 EUT Operating Condition

Environment:

Temperature	Humidity	Air Pressure
24 °C	54 %RH	1001 hpa

5.4.3 Results of Radiated Radio Frequency Electromagnetic (RS)

Model No. : UMBC-1100
 Tested By : Lion Lee
 Tested Date : December 20, 2021
 Test Mode : Mode 2
 Basic Standard : IEC/EN 61000-4-3
 Frequency range : 80 MHz - 1000 MHz
 Frequency range : 1800 MHz, 2600 MHz, 3500 MHz, 5000 MHz ($\pm 1\%$)
 Field strength : 3 V/m
 Modulation : 80% AM (1kHz)
 Frequency step : 1 % of fundamental
 Polarity of Antenna : Horizontal and Vertical
 Dwell Time : 3 seconds
 Test distance : 3 m

No.	Frequency (MHz)	Antenna Orientation	Observation	EUT Orientation
1	80 - 1000	Vertical/Horizontal	A	0 degree
2	80 - 1000	Vertical/Horizontal	A	90 degree
3	80 - 1000	Vertical/Horizontal	A	180 degree
4	80 - 1000	Vertical/Horizontal	A	270 degree

Remark: A: No degradation of performance or loss of function.

No.	Frequency (MHz)	Antenna Orientation	Observation	EUT Orientation
1	1800, 2600, 3500, 5000 ($\pm 1\%$)	Vertical/Horizontal	A	0 degree
2	1800, 2600, 3500, 5000 ($\pm 1\%$)	Vertical/Horizontal	A	90 degree
3	1800, 2600, 3500, 5000 ($\pm 1\%$)	Vertical/Horizontal	A	180 degree
4	1800, 2600, 3500, 5000 ($\pm 1\%$)	Vertical/Horizontal	A	270 degree

Remark: A: No degradation of performance or loss of function.

Model No. : UMBC-1100
 Tested By : Lion Lee
 Tested Date : December 20, 2021
 Test Mode : Mode 2 (Audio Mode)
 Basic Standard : IEC/EN 61000-4-3
 Frequency range : 80 MHz - 1000 MHz
 Frequency range : 1800 MHz, 2600 MHz, 3500 MHz, 5000 MHz ($\pm 1\%$)
 Field strength : 3 V/m
 Modulation : 80% AM (1kHz)
 Frequency step : 1 % of fundamental
 Polarity of Antenna : Horizontal and Vertical
 Dwell Time : 3 seconds
 Test distance : 3 m

No.	Frequency (MHz)	Antenna Orientation	Observation	EUT Orientation
1	80 - 1000	Vertical/Horizontal	A	0 degree
2	80 - 1000	Vertical/Horizontal	A	90 degree
3	80 - 1000	Vertical/Horizontal	A	180 degree
4	80 - 1000	Vertical/Horizontal	A	270 degree

Remark: A: No degradation of performance or loss of function.

No.	Frequency (MHz)	Antenna Orientation	Observation	EUT Orientation
1	1800, 2600, 3500, 5000 ($\pm 1\%$)	Vertical/Horizontal	A	0 degree
2	1800, 2600, 3500, 5000 ($\pm 1\%$)	Vertical/Horizontal	A	90 degree
3	1800, 2600, 3500, 5000 ($\pm 1\%$)	Vertical/Horizontal	A	180 degree
4	1800, 2600, 3500, 5000 ($\pm 1\%$)	Vertical/Horizontal	A	270 degree

Remark: A: No degradation of performance or loss of function.

5.5 Test of IEC/EN 61000-4-4

5.5.1 Test Instruments

Immunity Shield Room					
EQUIPMENT TYPE	Manufacturer	Model Number	Serial Number	Calibration Date	Calibration Due
Capacitive Clamp	EMC-Partner	CN-EFT1000	589	06/07/2021	06/06/2022
EMC Immunity Tester	EMC Partner	TRANSINT 2000	1117	02/26/2021	02/25/2022
Test Software	GenecsVer. 3.27				
Testing Site : No.163-1, Jhongsheng Rd., Xindian Dist., New Taipei City, Taiwan					

5.5.2 EUT Operating Condition

Environment:

Temperature	Humidity	Air Pressure
24 °C	47 %RH	1001 hpa

5.5.3 Results of Electrical Fast Transient (EFT)

Model No. : UMBC-1100
 Tested By : Lion Lee
 Tested Date : December 20, 2021
 Test Mode : Mode 2
 Basic Standard : IEC/EN 61000-4-4
 Test Voltage : AC Input: ± 1 kV
 Signal/Comm. : ± 0.5 kV
 Polarity : Positive/Negative
 Impulse Frequency : 5 kHz
 Tr/Th : 5/50ns
 Burst : 15ms/300ms

Observation:

Test Point	Polarity	Test Level (kV)	Results
L	+/-	1	A
N	+/-	1	A
PE	+/-	1	A
L-N	+/-	1	A
L-PE	+/-	1	A
N-PE	+/-	1	A
L-N-PE	+/-	1	A
RJ45	+/-	0.5	A

Remark: A: No degradation of performance or loss of function

5.6 Test of IEC/EN 61000-4-5

5.6.1 Test Instruments

Immunity Shield Room					
EQUIPMENT TYPE	Manufacturer	Model Number	Serial Number	Calibration Date	Calibration Due
CDN	EMC-Partner	CDN-UTP8	1505	12/09/2021	12/08/2022
EMC Immunity Tester	EMC Partner	TRANSINT 2000	1117	02/26/2021	02/25/2022
Test Software	GenecsVer. 3.27				
Testing Site : No.163-1, Jhongsheng Rd., Xindian Dist., New Taipei City, Taiwan					

5.6.2 EUT Operating Condition

Environment:

Temperature	Humidity	Air Pressure
24 °C	47 %RH	1001 hpa

5.6.3 Results of Surge Test

Model No. : UMBC-1100
 Tested By : Lion Lee
 Tested Date : December 20, 2021
 Test Mode : Mode 2
 Basic Standard : IEC/EN 61000-4-5
 Test Rate : 1 pulse every minute
 No. of Tests : 5 positive and 5 negative pulses
 Waveform : 1.2/50 μ s (8/20 μ s)

Observation Description

AC input line:

Test Point	Phase Angle (degree)	Polarity (+/-)	Test Level (kV)	Observation
L – N	0, 90, 180, 270	+/-	1	A
L – PE	0, 90, 180, 270	+/-	2	A
N – PE	0, 90, 180, 270	+/-	2	A

Remark: A: No degradation of performance or loss of function.

Signal line:

Test Rate : 1 pulse every minute
 No. of Tests : 5 positive and 5 negative pulses
 Waveform : 10/700 μ s

Observation Description

Signal line:

Test Point	Phase Angle (degree)	Polarity (+/-)	Test Level (kV)	Observation
RJ45	No phase angle (degree)	+/-	0.5	B

Remark: B: During test, the EUT's function degradation, Ethernet data ping loss. After test, it recover automatically afterwards.

5.7 Test of IEC/EN 61000-4-6

5.7.1 Test Instruments

CS Room					
EQUIPMENT TYPE	Manufacturer	Model Number	Serial Number	Calibration Date	Calibration Due
CDN	Teseq	CDN S751A	46649	11/03/2021	11/02/2022
CDN	Teseq	CDN M016	35821	11/03/2021	11/02/2022
CDN	TESEQ	CDN T400A	28547	11/03/2021	11/02/2022
CDN	FCC	FCC-801-M3-25A	9973	11/03/2021	11/02/2022
CDN	Teseq	CDN T8A-10	57182	05/26/2021	05/25/2022
Compact Immunity Test System	TESEQ	NSG 4070	39581	11/04/2021	11/03/2022
Test Software	NSG 4070 Control Program V1.2.0				
Testing Site : No.163-1, Jhongsheng Rd., Xindian Dist., New Taipei City, Taiwan					

5.7.2 EUT Operating Condition

Environment:

Temperature	Humidity	Air Pressure
25 °C	49 %RH	1001 hpa

5.7.3 Results of Immunity to Conducted Disturbances (CS)

Model No. : UMBC-1100
 Tested By : Lion Lee
 Tested Date : December 20, 2021
 Test Mode : Mode 2
 Basic Standard : IEC/EN 61000-4-6
 Frequency range : 0.15 MHz -10 MHz
 Field strength : 3 Vrms
 Frequency range : 10 MHz - 30 MHz
 Field strength : 3 V to 1Vrms
 Frequency range : 30 MHz - 80 MHz
 Field strength : 1 Vrms
 Modulation : 80% AM, 1 kHz Sinewave
 Frequency step : 1 % of fundamental
 Dwell Time : 3 seconds
 Coupling Method : CDN-M3, CDN-T8

Cable Description	Frequency (MHz)	Observation
AC input	0.15 – 80	A

Signal Ports

Cable Description	Frequency (MHz)	Observation
RJ45	0.15 – 80	A

Remark: A: No degradation of performance or loss of function.

Model No. : UMBC-1100
 Tested By : Lion Lee
 Tested Date : December 20, 2021
 Test Mode : Mode 2 (Audio Mode)
 Basic Standard : IEC/EN 61000-4-6
 Frequency range : 0.15 MHz -10 MHz
 Field strength : 3 Vrms
 Frequency range : 10 MHz - 30 MHz
 Field strength : 3 V to 1Vrms
 Frequency range : 30 MHz - 80 MHz
 Field strength : 1 Vrms
 Modulation : 80% AM, 1 kHz Sinewave
 Frequency step : 1 % of fundamental
 Dwell Time : 3 seconds
 Coupling Method : CDN-M3, CDN-T8

Cable Description	Frequency (MHz)	Observation
AC input	0.15 – 80	A

Signal Ports

Cable Description	Frequency (MHz)	Observation
RJ45	0.15 – 80	A

Remark: A: No degradation of performance or loss of function.

5.8 Test of IEC/EN 61000-4-8

5.8.1 Test Instruments

Immunity Shield Room					
EQUIPMENT TYPE	Manufacturer	Model Number	Serial Number	Calibration Date	Calibration Due
Testing Site : No.163-1, Jhongsheng Rd., Xindian Dist., New Taipei City, Taiwan					

5.8.2 EUT Operating Condition

Environment:

Temperature	Humidity	Air Pressure
N/A	N/A	N/A

5.8.3 Result of Immunity to Power Frequency Magnetic Field

Model No. : UMBC-1100
 Tested By : N/A
 Tested Date : N/A
 Test Mode : N/A
 Basic Standard : IEC/EN 61000-4-8
 Power Frequency : 50 Hz
 Magnetic Field : 1 A/m(r.m.s)
 Coil Orientation : X, Y, Z Axis
 Observation : N/A

Remark: N/A: There is no any sensitive part for magnetic field test. Applicable only to equipment containing susceptible to magnetic field.

5.9 Test of IEC/EN 61000-4-11

5.9.1 Test Instruments

Immunity Shielded Room					
EQUIPMENT TYPE	Manufacturer	Model Number	Serial Number	Calibration Date	Calibration Due
AC/DC Clamp Meter	Lutron	CM-9930R	I.200121	05/02/2021	05/01/2022
EMC Immunity Tester	EMC Partner	TRANSINT 2000	1117	02/26/2021	02/25/2022
Test Software	GenecsVer. 3.27				
Testing Site : No.163-1, Jhongsheng Rd., Xindian Dist., New Taipei City, Taiwan					

5.9.2 EUT Operating Condition

Environment:

Temperature	Humidity	Air Pressure
24 °C	47 %RH	1001 hpa

5.9.3 Results of Voltage Dips Immunity Test

Model No. : UMBC-1100
 Tested By : Lion Lee
 Tested Date : December 20, 2021
 Test Mode : Mode 2
 Basic Standard : IEC/EN 61000-4-11
 EUT Rated Voltage : 230 Volts.
 Reduction Voltage : 30, >95 % Ut
 Phase Angle : 0,180 degree
 Total events : 3 dropouts
 Event interval : 10 seconds

Test Power: 230Vac, 50Hz			
Environmental phenomena	Test specification (% reduction)	Duration (in periods of the rated frequency)	Observation
Voltage Interruptions	>95	250	C
Voltage dips	30	25	A
	>95	0.5	A

Test Power: 230Vac, 60Hz			
Environmental phenomena	Test specification (% reduction)	Duration (in periods of the rated frequency)	Observation
Voltage Interruptions	>95	300	C
Voltage dips	30	30	A

Remark: A: No degradation of performance or loss of function.

C: EUT shut down, it could not become normal except reinstalled by operator.

APPENDIX

Photograph of Testing General Set-up

CE Testing Set-up



ISN Testing Set-up



RE Testing Set-up

Below 1GHz



Above 1GHz

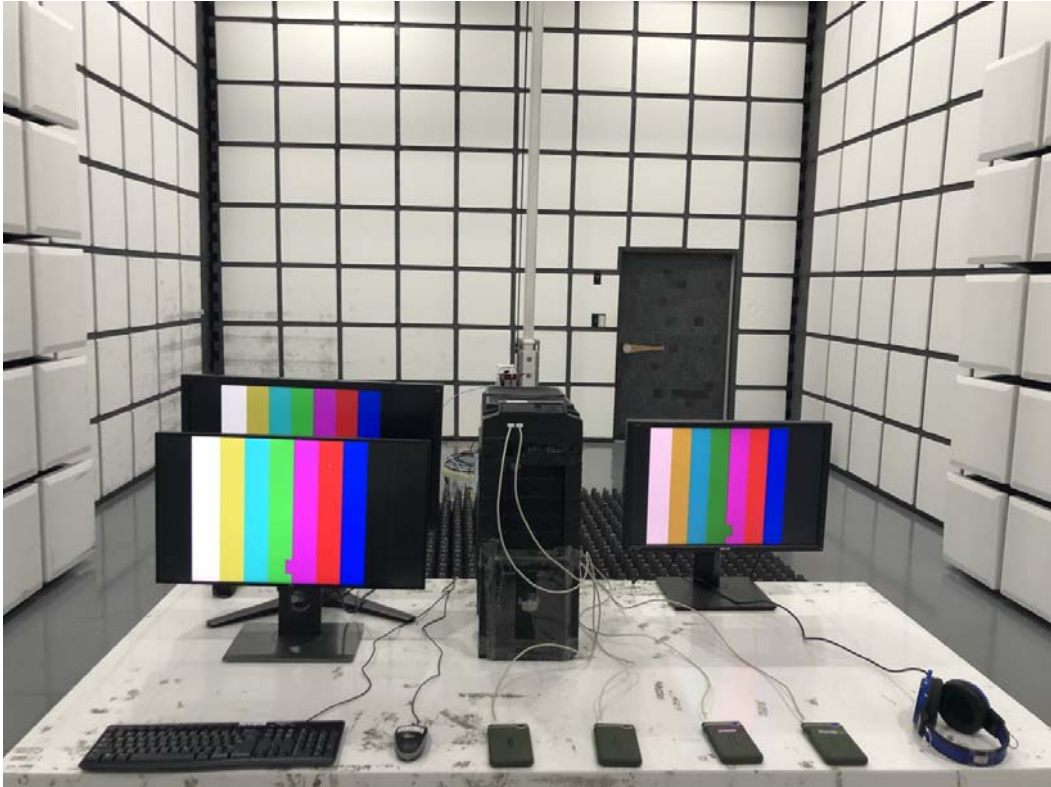

HARMONIC & FLICKER Testing Set-up

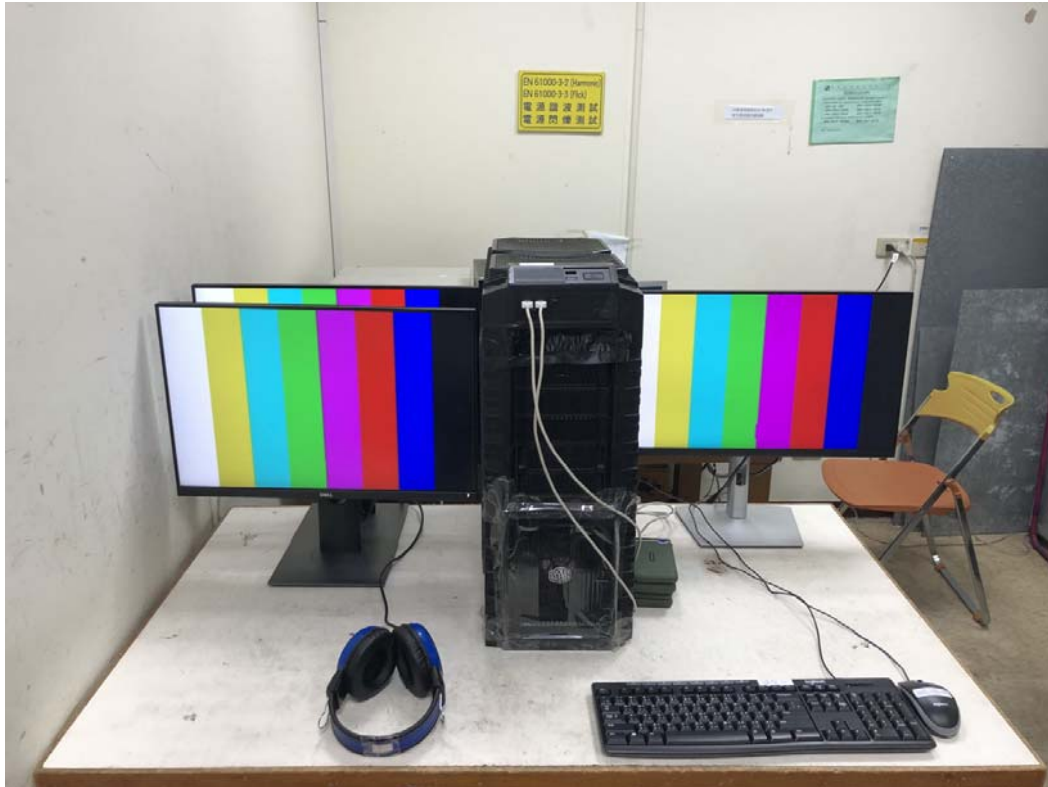

ESD Testing Set-up



RS Testing Set-up

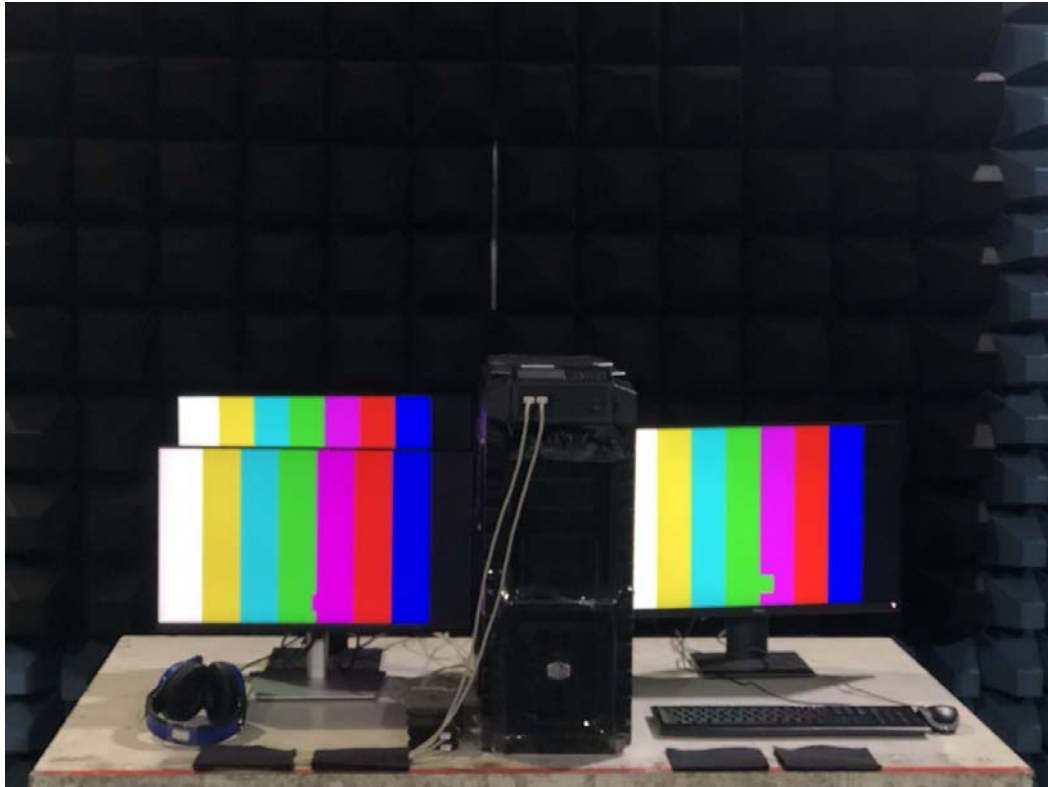

RS Testing Set-up (Audio Mode)

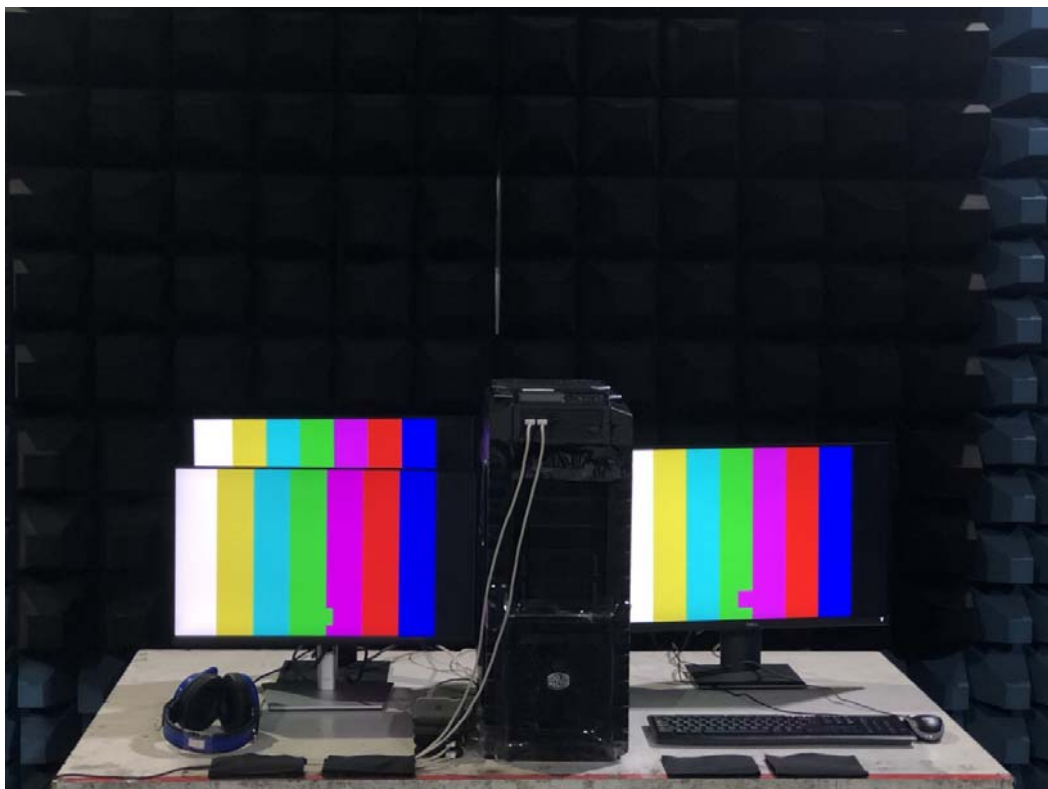

EFT Testing Set-up

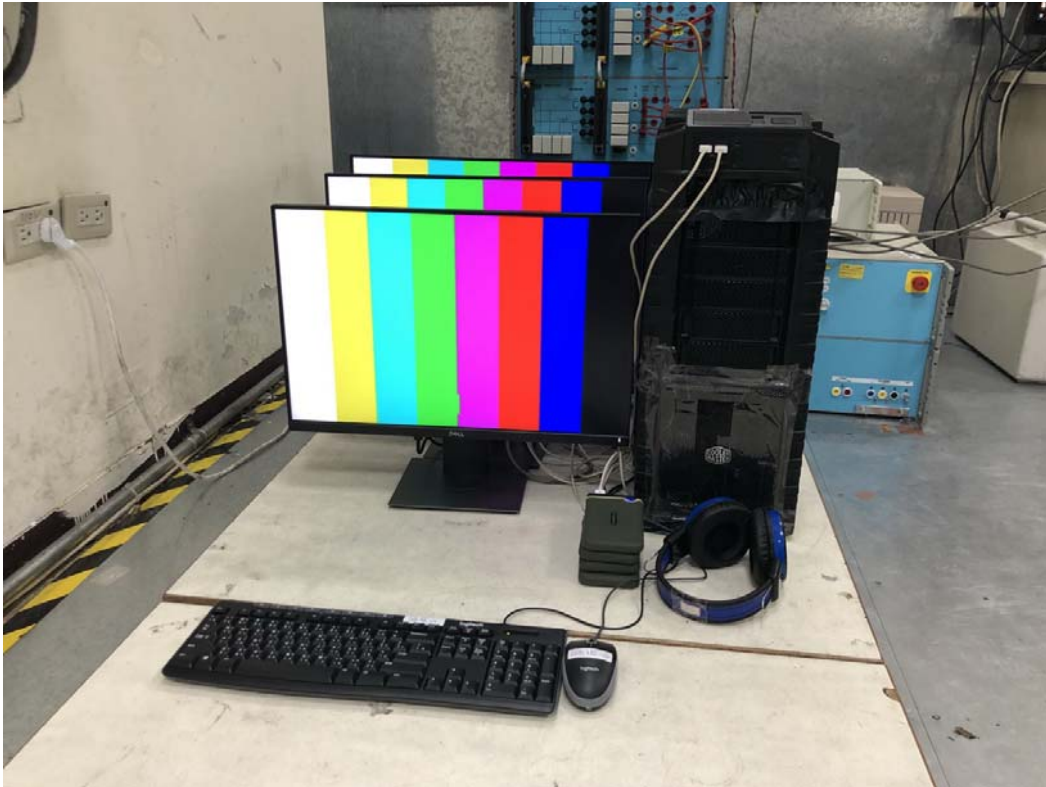

EFT For RJ45 Testing Set-up

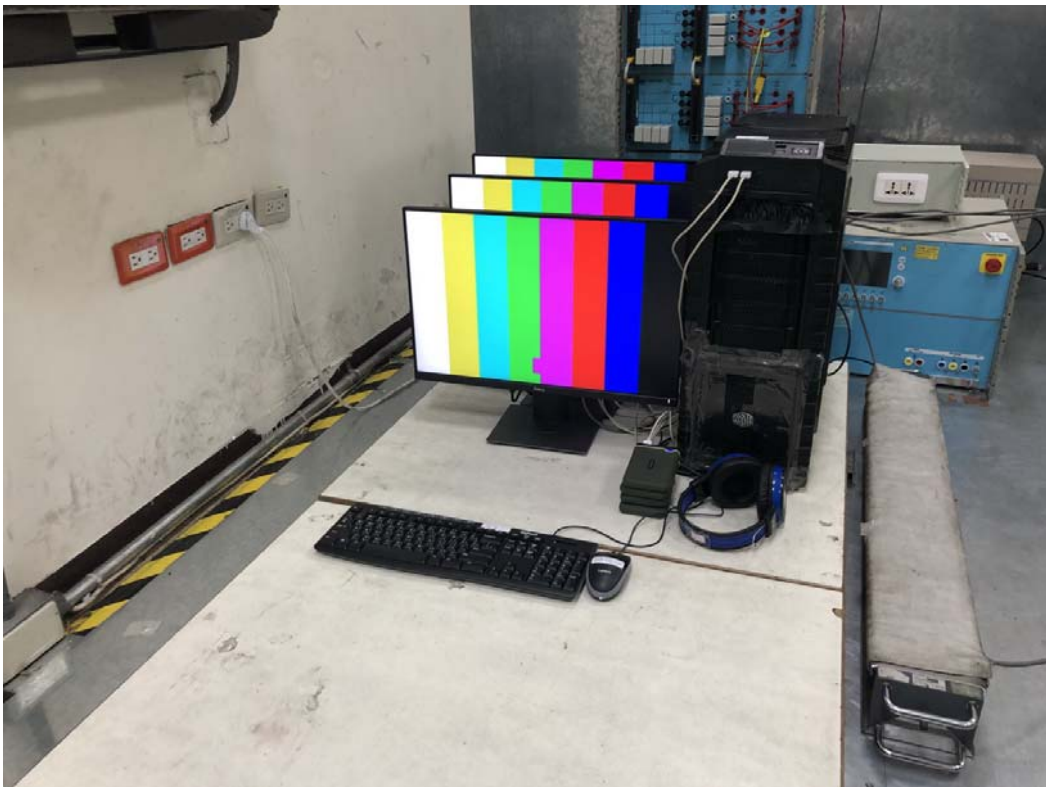

Surge Testing Set-up



Surge For RJ45 Testing Set-up



CS Testing Set-up

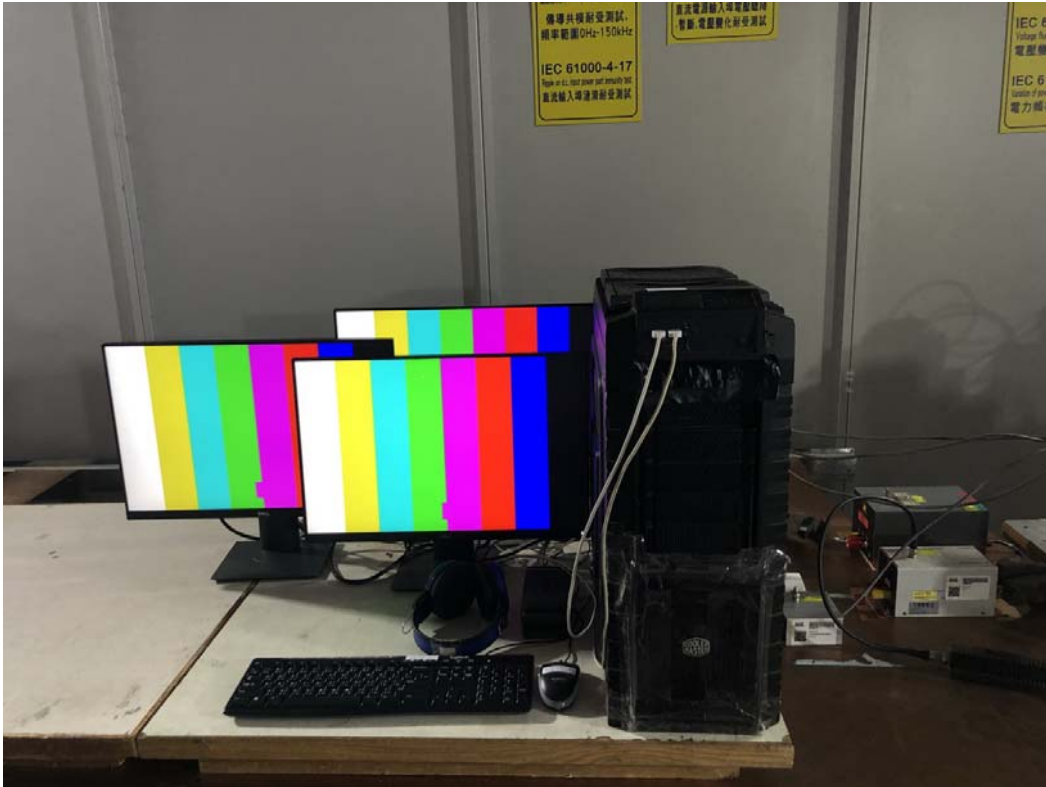

CS Testing Set-up (Audio Mode)



CS For RJ45 Testing Set-up



CS For RJ45 Testing Set-up (Audio Mode)



DIP Testing Set-up

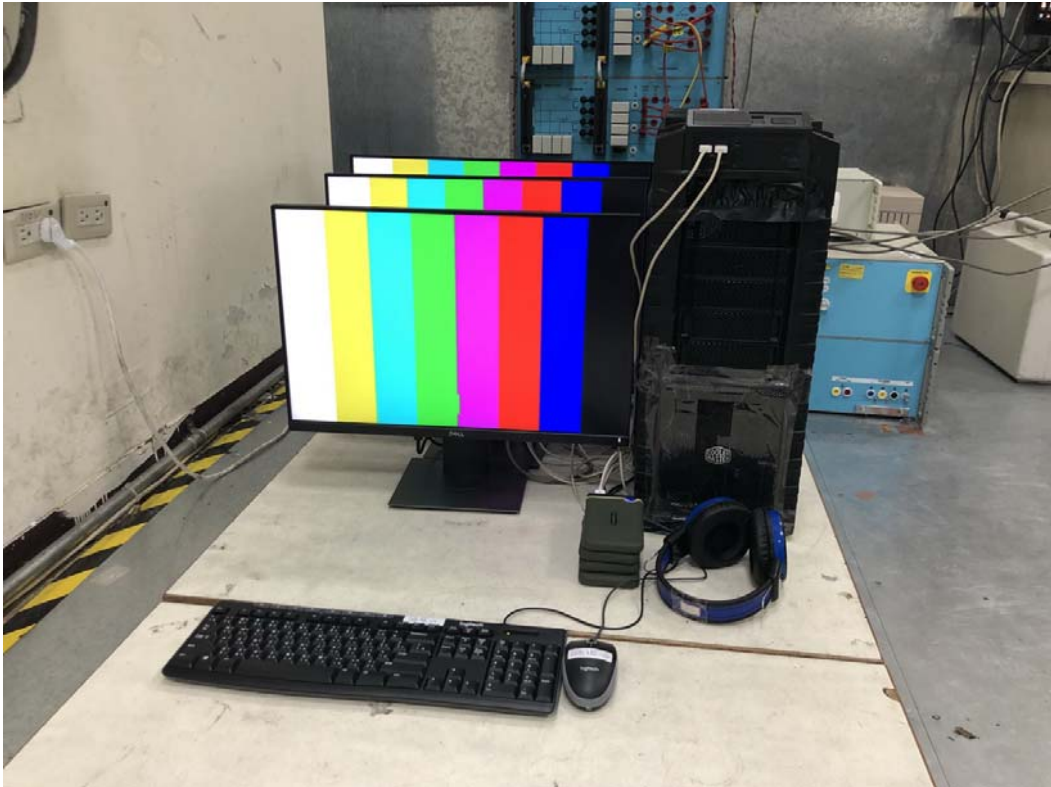

Photographs of EUT Unit Exterior





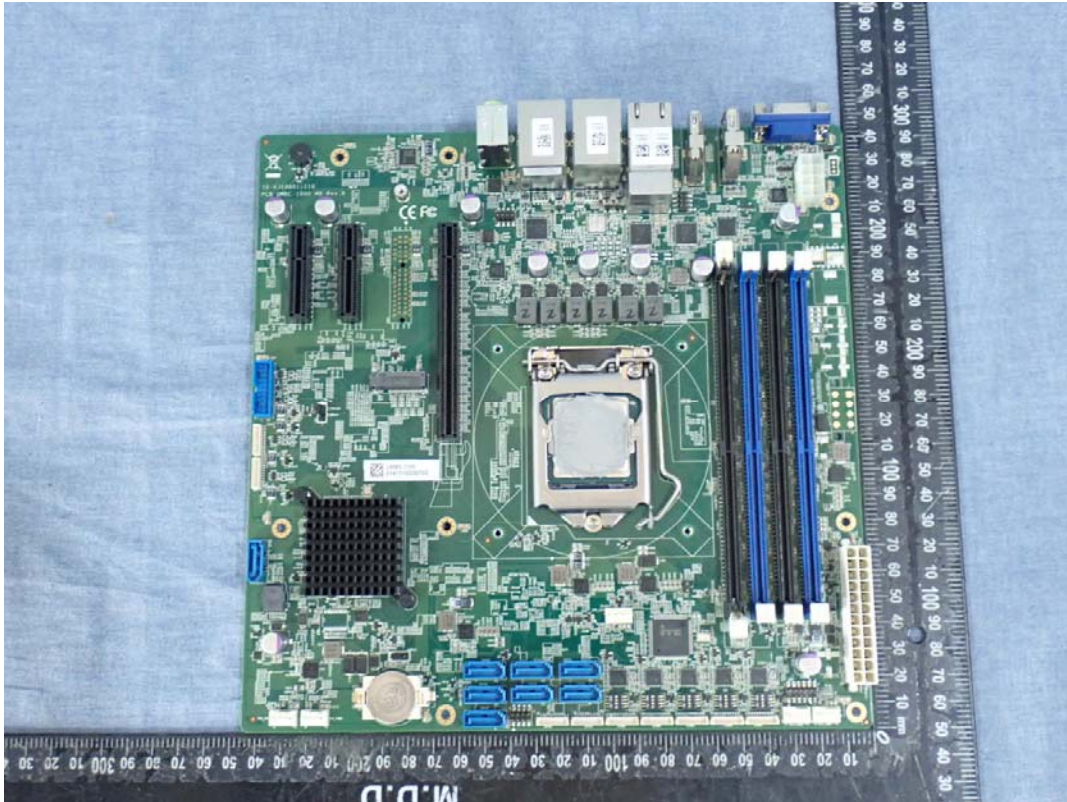



**** End of Report ****